

Reg. No. \_\_\_\_\_

Name: \_\_\_\_\_

**APJ ABDUL KALAM TECHNOLOGICAL UNIVERSITY**

FIRST SEMESTER B.TECH DEGREE EXAMINATION, JANUARY 2017

Course Code: **BE101-03**Course Name: **INTRODUCTION TO ELECTRICAL ENGINEERING**

Max. Marks: 100

Duration: 3 Hours

**PART A***Answer All Questions. 4 Marks each*

1. Distinguish between statically induced EMF and dynamically induced EMF. List few electric equipments working on these principles.
2. Draw the V-I characteristics of ideal and practical voltage and current sources.
3. Find current through  $20\text{k}\Omega$  resistor in the circuit shown below using Kirchoff's Law.

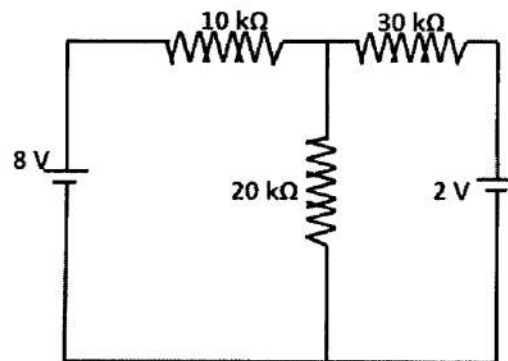
**Fig-1**

4. Draw the circuit of a series parallel magnetic circuit. Show its electrical equivalent.
5. Why RMS value is used instead of average value for an alternating quantity? Show that for sinusoidal voltage, RMS value is 0.707 times its maximum value.
6. A pure inductance of  $318\text{ mH}$  is connected in series with a pure resistance of  $75\Omega$ . This circuit is supplied from a  $50\text{Hz}$  sinusoidal source and voltage across the  $75\Omega$  resistance is found to be  $150\text{V}$ . Calculate the supply voltage.
7. Define (a) active power, (b) reactive power, (c) apparent power and (d) power factor in an ac circuit.
8. An RLC circuit connected to a variable frequency voltage source is shown below (Fig 2). What will be the value of impedance at resonance, current through the circuit at resonance and resonance frequency of the circuit?

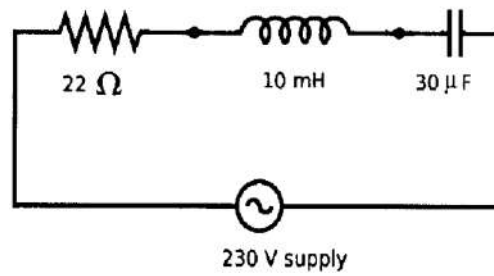

Fig-2

9. What are the advantages of three phase power generation?
10. Derive the Line and Phase voltage relationship in a star connected three phase circuit with the help of Phasor diagram.

### PART B

*Answer any four full questions*

11. (a) Define (a) self inductance (b) mutual inductance and write the expression of coefficient of coupling. (6)
- (b) Derive the expression for energy stored in inductance. (4)
12. (a) State Kirchhoff's first law and second law. These laws express the conservation of two important physical quantities. Name the quantities. (3)
- (b) Find the voltage between A and B of the circuit shown in Fig-3 using Mesh analysis. (7)

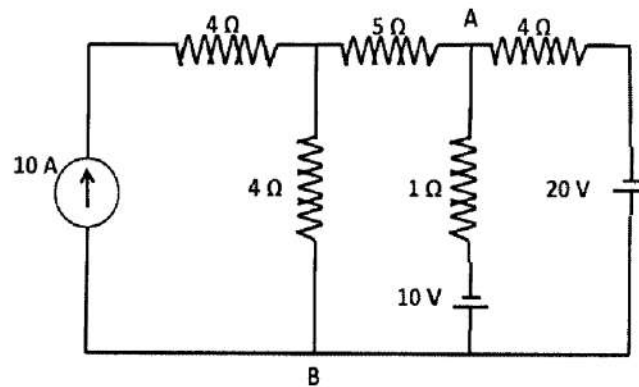

Fig-3

13. a) Find the current through the 20 Ω resistor shown in the Fig-4 by using nodal analysis. (6)

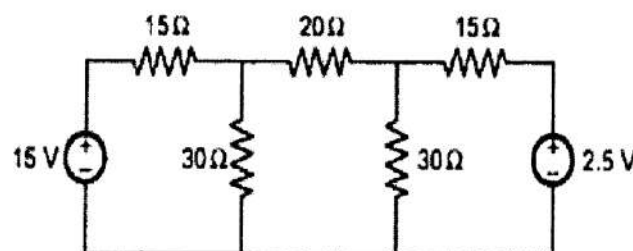

Fig-4

- (b) In the network shown determine the equivalent resistance between the terminals A and B. (4)

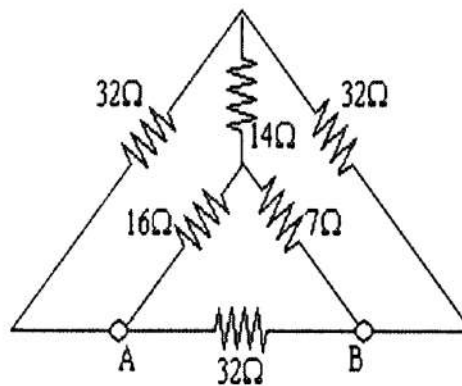

Fig-5

14. a) Compare electric and magnetic circuits (3)  
 (b) A mild steel ring of 30 cm mean circumference has cross sectional area of  $6\text{cm}^2$  and has winding of 500 turns on it. The ring is cut to provide an air -gap of 1mm in the magnetic circuit. It is found that a current of 4A in the winding produces a flux density of 1Tesla in the air gap. Find the following (7)
- I. Relative permeability of mild steel
  - II. Inductance of the winding
15. A full wave rectified sine function is clipped at 0.707 of its maximum value as shown in fig-6. Find the average and rms values of the function.

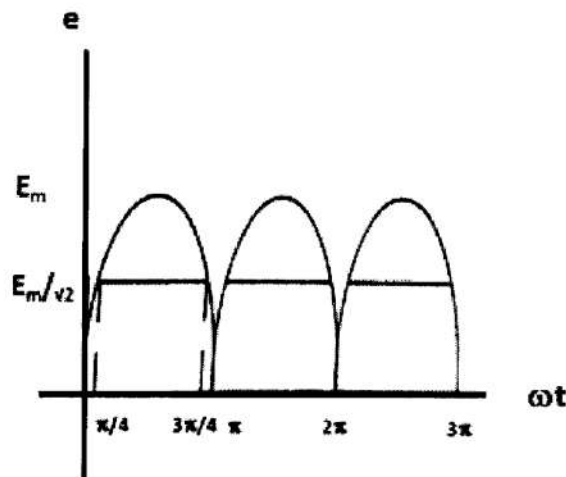

Fig-6

16. a) A current of 5A flows through a non-inductive resistance in series with a choke coil when supplied at 250V, 50Hz. If the voltage across the resistance is 125V and across the coil is 200V, calculate the following.
- i. Impedance, reactance and resistance of coil (3)
  - ii. Power absorbed by the coil (2)
  - iii. Total Power (1)
- (b) Prove that the power consumed in a purely capacitive circuit is zero (4)

## PART-C

Answer Two full questions 17 or 18 and 19 or 20

17. (a) Two impedances  $(10 + j5\Omega)$  and  $(25 - j10\Omega)$  are connected in parallel across 100V, 50Hz supply. Find the total current, branch currents, power factor and power consumed. (6)
- (b) The apparent power drawn by an AC circuit is 10KVA and active power is 8KW. What is the reactive power and power factor of the circuit? (4)
18. (a) Sketch the variation of impedance in series resonance circuit (2)
- (b) An RLC series circuit has  $R=10\Omega$ ,  $L=0.1H$ ,  $C=8\mu F$  Calculate the following
- Resonant frequency (2)
  - Q-factor of the circuit at resonance (2)
  - Half power frequencies and band width (4)
19. Two single phase wattmeter are used to measure three phase power. The readings of the two wattmeter are 2000W and 400W respectively. Calculate the following
- Power factor of the circuit. (6)
  - What would be the power factor if the reading of the second wattmeter is negative? (4)
20. (a) Derive the expression for power and power factor in a balanced three phase system using two wattmeter method. (6)
- (b) A star connected balanced load with per phase impedance of  $(8+j6)\Omega$  is shown in figure. (4)

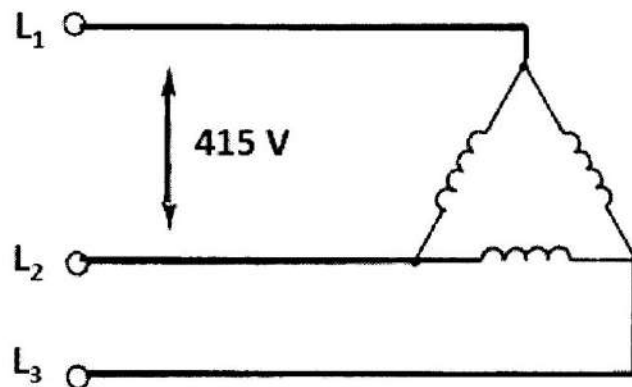

Fig-7

- What is the value of per phase voltage?
- What will be the per phase current?
- What will be the line current?